

smart interior design

FOR YOUR OFFICE

WWW.SMARTINTERIOR.RO

Complementary BASIC

v4.2021

Pedestals

	BASIC	
drawer	MFC	
body	black, white, aluminum or anthracite	
top and front	MFC in all colours	
pencil tray	plastic pencil tray	
ball runners	not available	
soft closing	not available	
handle STANDARD		
handle PRO (optional)		

Cabinets

	BASIC	
back	3 mm HDF	
body	black, white, aluminum or anthracite	
metal base	not available	
wide angle hinges	not available	
glass top for storages 801 mm wide	not available	
handle STANDARD		
front PRO (optional)		

Colour combination - Basic - pedestals and storage systems

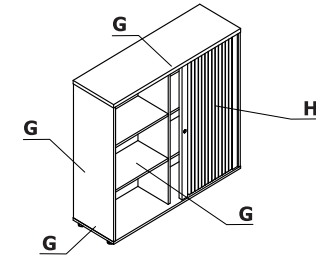
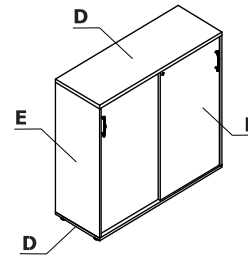
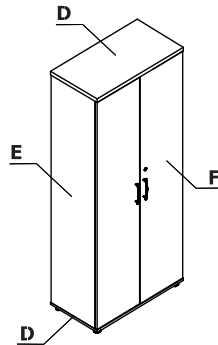
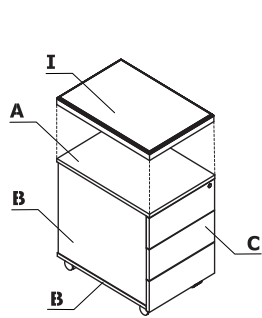

Material	Colour	Pedestal				Storages					Pedestal cushion				
		A - Top	B - Body, base	C - Front	Whole - KKT11, KKT110	D - Top, base	E - Body	F - Front	G - K3Z06	H - Tambour front		I - SKP13			
MFC	26 - aluminum satinato	✓	✓	✓	✓	✓	✓	✓	✓	✓					
	31 - canadian oak	✓		✓		✓		✓							
	34 - chestnut	✓		✓		✓		✓							
	39 - polar birch	✓		✓		✓		✓							
	64 - cocoa	✓		✓		✓		✓							
	67 - white pastel	✓	✓	✓	✓	✓	✓	✓	✓	✓					
	106 - lowland walnut	✓		✓		✓		✓							
	154 - anthracite	✓	✓	✓	✓	✓	✓	✓	✓	✓					
	08 - black	✓	✓	✓	✓	✓	✓	✓	✓	✓					
	167 - grey oak	✓		✓		✓		✓							
	168 - natural oak	✓		✓		✓		✓							
	169 - honey oak	✓		✓		✓		✓							
	170 - acacia	✓		✓		✓		✓							
	171 - dark walnut	✓		✓		✓		✓							

Material	Colour	Pedestal				Storages					Pedestal cushion				
		A - Top	B - Body, base	C - Front	Whole - KKT11, KKT110	D - Top, base	E - Body	F - Front	G - K3Z06	H - Tambour front		I - SKP13			
Fabric	Nemo										✓				
	Runner										II group ✓				
	Medley										II group ✓				
	**Atlantic										II group ✓				
	Vita										II group ✓				
	Mica										II group ✓				
	Go Check										II group ✓				
	Charles										II group ✓				
	Xtreme										III group ✓				
	Synergy										III group ✓				
	***Silvertex										III group ✓				
	*Customer's own fabric										II group ✓				
	Atlas										IV group ✓				
Field2										IV group ✓					

* Employing the customer's fabric requires running upholstery tests in order to check the possibility of realisation.

*** There is a possibility of ordering the product in full colour spectrum of Silvertex range, as per Spradling's pattern book, within 15 working days.

** There is a possibility of ordering the product in full colour spectrum of Atlantic range, as per Gabriel's pattern book, within 8 weeks

Mobile pedestal without handles

- 1 **Body** - MFC 18 mm, ABS edge
- 2 **Front** - MFC 18 mm, ABS edge
- 3 **MFC drawer** - roll runners, max load 25 kg, 80% extractio
- 4 **Sliding pencil tray** - MFC 18 mm
- 5 **Pencil tray** - plastic, colour: black
- 6 **Central lock** - foldable key
- 7 **Castors** - Ø50 mm, two with brakes
- 8 **Optional cushion SKP13** - for pedstal, max load 120 kg, ordered separately

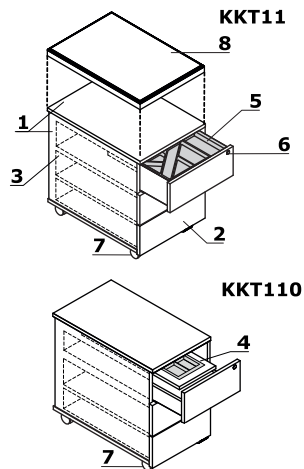

ATTENTION - Sitting on the pedestal KKT11 possible only after mounting the cushion (SKP13); the pedestal with cushion is intended for sitting only - moving the pedestal while sitting may result in damaging the castors

Mobile pedestals

- 1 **Top** - MFC 18 mm, ABS edge
- 2 **Body** - MFC 18 mm, ABS edge
- 3 **Front** - MFC 18 mm, ABS edge
- 4 **MFC drawer** - roll runners, max load 25 kg, 80% extractio
- 5 **Sliding pencil tray** - MFC 18 mm
- 6 **Pencil tray** - plastic, colour: black
- 7 **Suspension files drawer** - max load 30 kg, 80% extraction; A4 folders can be situated perpendicularly to the front
- 8 **Central lock** - foldable key
- 9 **Castors** - Ø50 mm, two with brakes

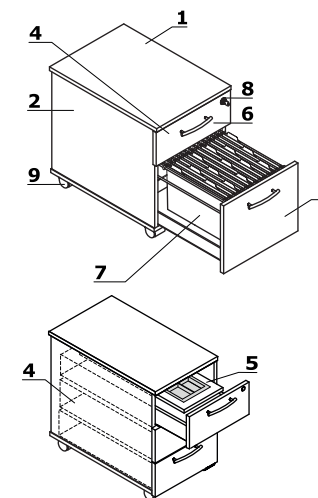

ATTENTION - sitting on the pedestal KKT12, KKT13 possible only after mounting the cushion (SKP13); the pedestal with cushion is intended for sitting only - moving the pedestal while sitting may result in damaging the castors

Stationary pedestals

- 1 **Top** - MFC 28 mm, ABS edge
- 2 **Body** - MFC 18 mm, ABS edge
- 3 **Front** - MFC 18 mm, ABS edge
- 4 **MFC drawer** - roll runners, max load 25 kg, 80% extractio
- 5 **Pencil tray** - plastic, colour: black
- 6 **Central lock** - foldable key
- 7 **Leveling** - 10 mm range

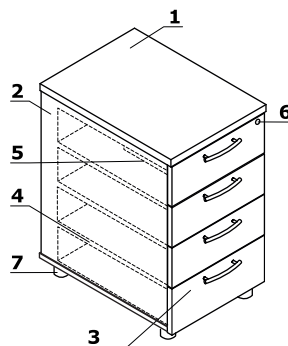

Pedestals with top overhang - dimensions (mm)

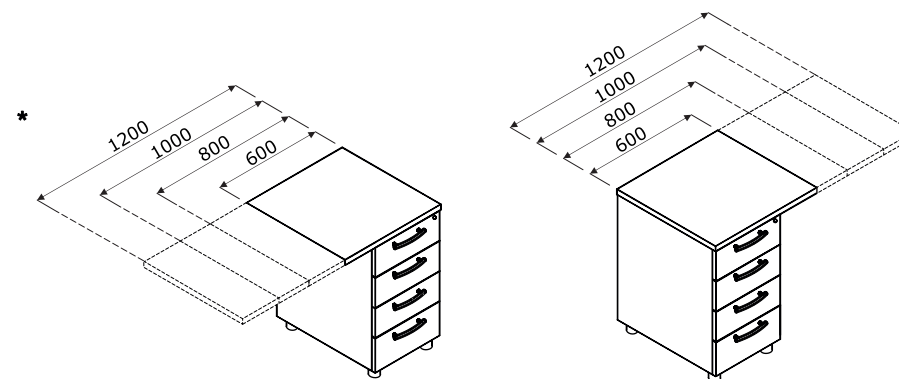

* Pedestal with top overhang

Storages

- 1 **Top** - MFC 28 mm, ABS edge
- 2 **Body** - MFC 18 mm, ABS edge
- 3 **Back MFC** - 3 mm, no edging
- 4 **Front** - MFC 18 mm, ABS edge, plain hinge 110°
- 5 **Patent lock**
- 6 **Aluminum handle**
- 7 **Shelf** - MFC 18 mm, protection against accidental falling-out, ABS edge
- 8 **Leveling feet 27 mm** - range 5 mm
- 9 **Base** - MFC 18 mm, ABS edge

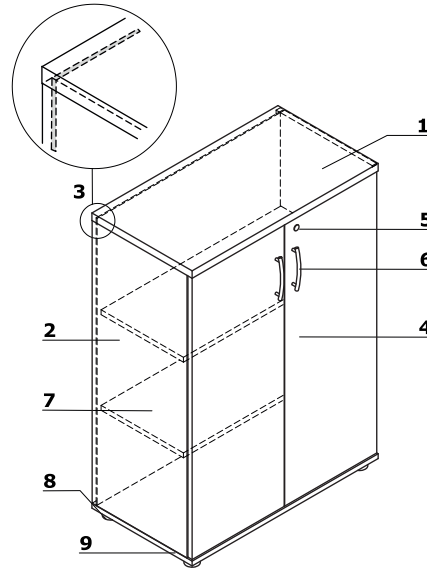



ATTENTION - Raw 3 mm HDF is visible on the back

Additional elements for storages

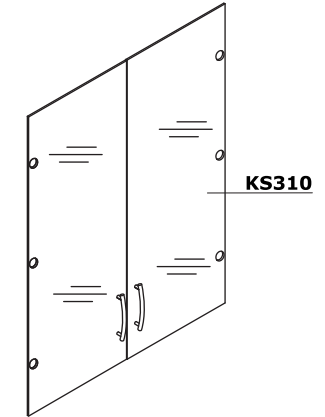
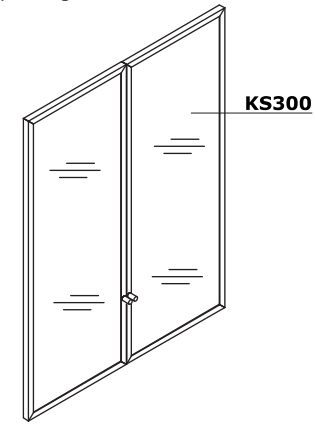
- 1 **KS300**
 - glass door 30H
 - frosted tempered glass 4 mm, with aluminum frame
- 2 **KS310**
 - glass door 30H
 - transparent tempered glass 4 mm

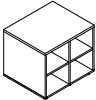

Accessories							
	Symbol	Price RON with TVA	Dimensions			kg m3 pcs	Comments
			Width	Depth	Height		
	SKP13	406,-	400	600	52	3 kg 0.017 m3 1 pcs	pedestal cushion
	S85	936,-	710	600	600	32 kg 0.066 m3 1 pcs	under printer storage, colours: 26-aluminium satinato, 67-white pastel, 154-anthracite
	ZT1000	182,-	15	15	0	0.5 kg 0.001 m3 1 pcs	plugs for holes ø 15mm 1000pcs

Extra charge RON with TVA						
II Price group	III Price group	IV price group				
57,-	135,-	192,-				

Colour combination - Dispensers

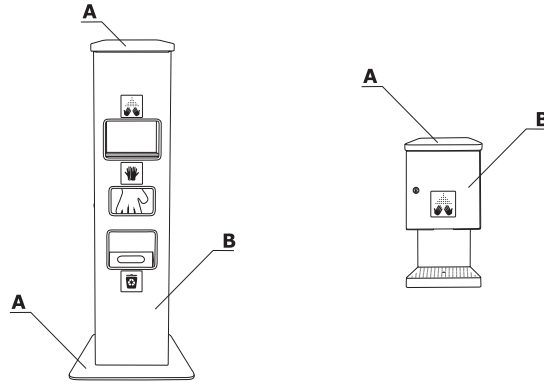

Material	Colour	DZW1, DZW2															
		A - Top cover, base	B - Case														
	Black RAL9005	✓															
	Grey RAL9006		✓														

Disinfection dispensers

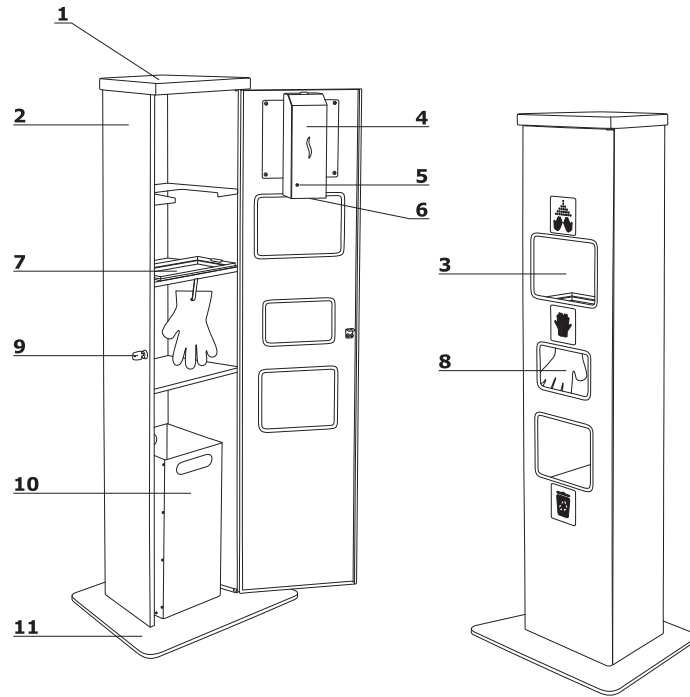

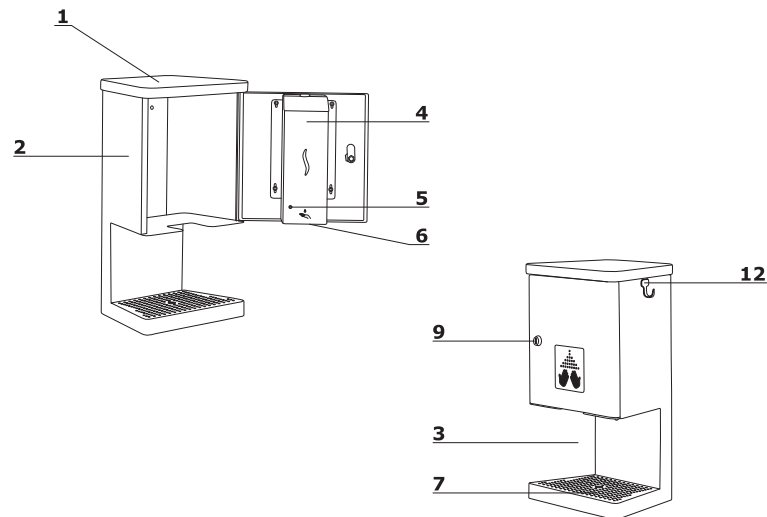

- 1 Top cover** - plate coated in epoxy paint, colour: black (RAL9005)
- 2 Case** - plate coated in epoxy paint, colour: grey (RAL9006); 1,5 mm thick
- 3 Hand disinfection area**
- 4 Disinfectant dispenser** - automatic (motion detector); plastic ABS, white; 1000ml capacity; ability to check the disinfectant level inside the dispenser; powered by 4xAA RL (1,5V - batteries included); manual refill through the inlet, closing - plastic lock with key
- 5 Low battery indicator**
- 6 Disinfectant nozzle** - system: non-spill valve
- 7 Drip tray for excess liquid** - capacity 230ml
- 8 Disposable gloves distribution area** - gloves included (100 pcs.)
- 9 Lock with key**
- 10 Waste container** - capacity about 22l
- 11 Base** - plate coated in epoxy paint, colour: grey (RAL9006); 5 mm thick
- 12 Hook** - for hanging disposable gloves

**General information:**

- the device can be set up and used both inside and outside the building, provided that - it is situated under a roof, sheltered against rain, and that the ambient temperature is above 0 ° C
- does not require connection to an electrical outlet
- use only legally approved disinfectants
- disinfectant refilling should be done by someone familiar with the device
- damaged signs and instructions on the device must be replaced immediately
- dispenser warranty - 12 months
- the distance required to start the dispenser - 8-12 cm
- DZW2 - possibility to mount on the wall

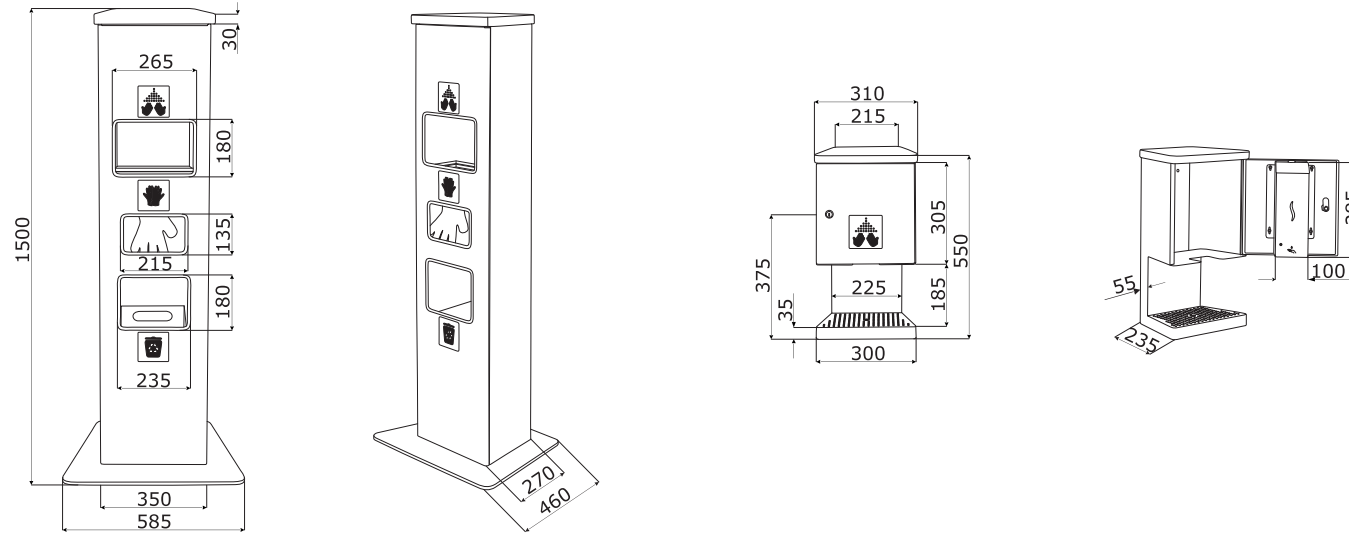
Dimensions (mm)

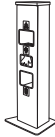











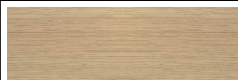
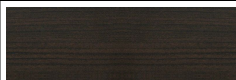
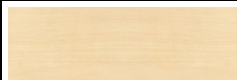
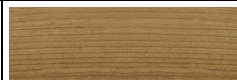

Disinfection dispensers							
	Symbol	Price RON with TVA	Dimensions			kg m3 pcs	Comments
			Width	Depth	Height		
	DZW1	5200,-	520	400	1495	41 kg 0.312 m3 1 pcs	brak
	DZW2	3796,-	310	235	550	11 kg 0.052 m3 1 pcs	brak

Extra charge RON with TVA							

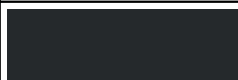
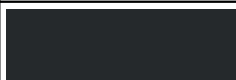
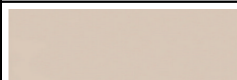
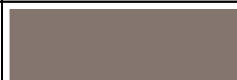

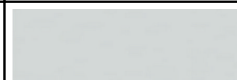
MFC

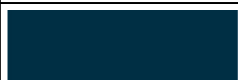
 08 - black	 26 - aluminum satinato	 31 - canadian oak	 34 - chestnut	 39 - polar birch	 64 - cocoa	 67 - white pastel	 106 - lowland walnut
 154 - anthracite	 167 - grey oak	 168 - natural oak	 168 - natural oak	 169 - honey oak	 170 - acacia		









HPL

 08 - black	 26 - aluminum satinato	 31 - canadian oak	 34 - chestnut	 39 - polar birch	 64 - cocoa	 67 - white pastel	 73 - white high gloss
 101 - black high gloss	 148 - grey high gloss	 154 - anthracite	 155 - anthracite high gloss	 174 - beige matte	 175 - truffle matte	 176 - red matte	 177 - grey matte RAL 7042
 178 - avocado matte	 179 - bottle green matte	 180 - Prussian blue matte	 184 - sky-blue matte				



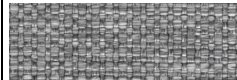





Polyurethane/polypropylene

 White high gloss	 Black high gloss
--	--

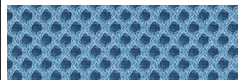
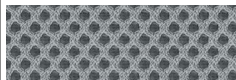

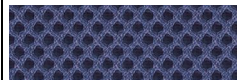







Fabric Nemo - first price group

 NE-1 - beige	 NE-2 - yellow	 NE-3 - orange	 NE-5 - red	 NE-9 - green	 NE-10 - grey	 NE-14 - graphite	 NE-15 - navy blue
 NE-16 - black	 NE-17 - blue						







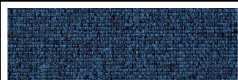
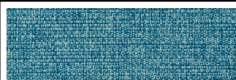
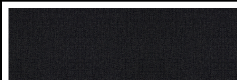



Fabric Runner - second price group

 R-63034 - orange	 R-64089 - red	 R-66063 - blue	 R-60011 - grey	 R-68056 - green	 R-66064 - navy blue	 R-60999 - black	 R-60025 - graphite
 R-61128 - beige	 R-61130 - brown						



Fabric Medley - second price group

 M-66008 - grey	 M-60003 - light grey	 M-61002 - beige	 M-68005 - dark olive	 M-62002 - yellow	 M-62054 - mustard	 M-63017 - rust-brown	 M-64019 - red
 M-63064 - pink	 M-65011 - grey-violet	 M-66010 - blue	 M-67006 - light blue	 M-60999 - black			











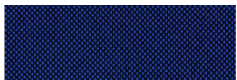



Fabric Atlantic - second price group (Remaining Atlantic colours, as per Gabriel's pattern book, available within 8 weeks)

 A-67043 - dark turquoise	 A-67030 - aquamarine	 A-60141 - light grey	 A-60011 - grey	 A-66064 - navy blue	 A-65037 - violet	 A-62048 - olive	 A-64089 - red
 A-61078 - beige	 A-60025 - graphite						











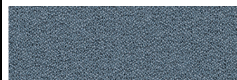

Fabric Charles - second price group

 C-01 - black	 C-05 - grey	 C-06 - beige	 C-14 - brown	 C-18 - rust-brown	 C-21 - red	 C-30 - pink	 C-31 - marsala
 C-32 - dark blue	 C-35 - blue	 C-41 - yellow	 C-44 - olive	 C-45 - green			

Fabric Go check - second price group

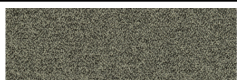
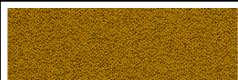
 G-66136 - blue	 G-66137 - dark blue	 G-66134 - dark violet	 G-66138 - navy blue	 G-66140 - inky	 G-68149 - dark green	 G-68152 - green	 G-60079 - grey
 G-64183 - marsala	 G-63079 - orange	 G-64171 - red	 G-64172 - burgundy	 G-61144 - brown	 G-61145 - dark brown		

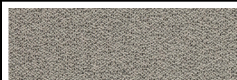
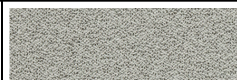
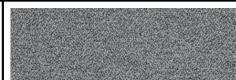
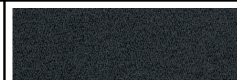
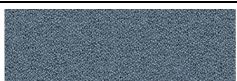
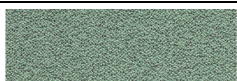







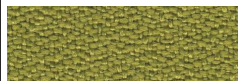

Fabric Mica - second price group

 MC-01 - pink	 MC-02 - red	 MC-03 - dark red	 MC-04 - navy blue	 MC-05 - blue	 MC-06 - aquamarine	 MC-07 - bottle green	 MC-08 - green
 MC-09 - olive	 MC-10 - light olive	 MC-11 - mustard	 MC-12 - yellow	 MC-13 - beige	 MC-14 - light grey	 MC-15 - grey	 MC-16 - graphite
 MC-17 - light blue	 MC-18 - mint	 MC-19 - burgundy					

Fabric Synergy - third price group

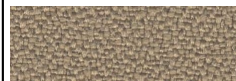
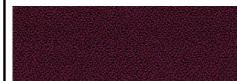







 LDS08 - grey melange	 LDS20 - light grey	 LDS27 - black	 LDS29 - dark grey	 LDS50 - dark green	 LDS53 - green	 LDS57 - turquoise	 LDS60 - bottle green
 LDS61 - plum	 LDS69 - navy blue	 LDS84 - orange	 LDS86 - red	 LDS88 - aubergine	 LDS85 - coral	 LDS19 - beige	 LDS44 - yellow
 LDS79 - brown							

Fabric Xtreme - third price group

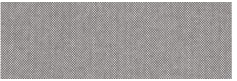
 XR026 - navy blue	 XR009 - black	 XR420 - olive	 XR081 - dark grey	 XR094 - grey	 XR108 - beige	 YS071 - light brown	 YS030 - burgundy
 YS076 - orange	 YS072 - yellow	 YS045 - green	 YS100 - blue				

Fabric Silvertex - third price group - There is a possibility of ordering the product in full colour spectrum of Silvertex range, as per Spradling's pattern book, within 15 working days.

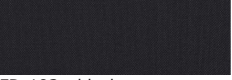
Fabric Atlas - fourth price group							
							
AS-531 - orange	AS-501 - pink	AS-651 - red	AS-681 - burgundy	AS-391 - brown	AS-781 - navy blue	AS-161 - dark grey	AS-111 - light grey
							
AS-971 - light green	AS-981 - dark green						

Fabric Field2 - fourth price group							
							
FD-463 - yellow	FD-963 - green	FD-123 - beige	FD-132 - grey	FD-142 - graphite	FD-662 - red	FD-782 - navy blue	FD-693 - burgundy
							
FD-192 - black	FD-673 - blue-red						