

smart interior design

FOR YOUR OFFICE

WWW.SMARTINTERIOR.RO

Executive IMPULS

v4.2021

Colour combination - Impuls

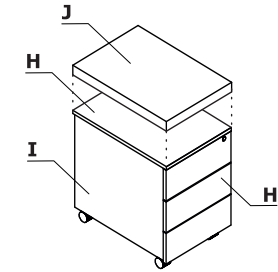
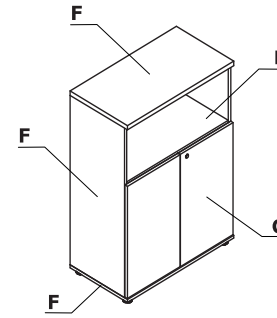
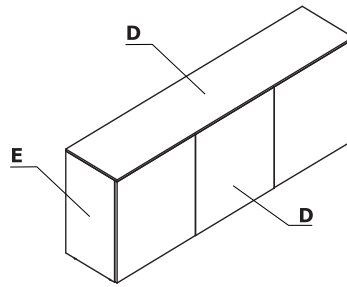
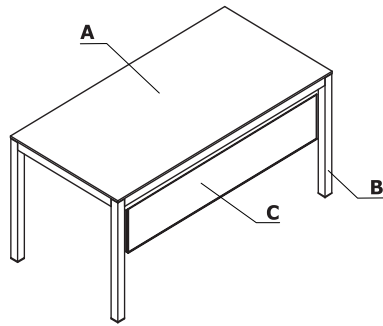

Material	Colour	Desks and modular table			Cabinet		Storages		Mobile pedestal without handles		Complementary elements					
		A - Top	B - Frame	C - Modesty panel	D - Top, front	E - Body	F - Top, base, body	G - Front	H - Top, front	I - Body	A800GT	J - SKP13				
MFC	08 - black	✓		✓	✓	08 - black	✓			✓	Glass black					
	31 - canadian oak	✓			✓	31 - canadian oak										
	34 - chestnut	✓			✓	34 - chestnut										
	67 - white pastel	✓		✓	✓	67 - white pastel	✓			✓	Glass white					
	167 - grey oak	✓			✓	34 - chestnut										
	168 - natural oak	✓			✓	34 - chestnut										
Glass	116 - glass black - RAL 9005	✓			✓	08 - black										
	117 - glass white - RAL 9003	✓			✓	67 - white pastel										
Metal	M115 - black semi-matt RAL 9005		✓													
	M015 - white semi-matt RAL 9010		✓													

Material	Colour	Desks and modular table			Cabinet		Storages		Mobile pedestal without handles		Complementary elements				
		A - Top	B - Frame	C - Modesty panel	D - Top, front	E - Body	F - Top, base, body	G - Front	H - Top, front	I - Body	A800GT	J - SKP13			
Fabric	Nemo											✓			
	Runner											II group ✓			
	Medley											II group ✓			
	**Atlantic											II group ✓			
	Vita											II group ✓			
	River											II group ✓			
	Xtreme											III group ✓			
	Synergy											III group ✓			
	***Silvertex											III group ✓			
	Atlas											IV group ✓			
	Field2											IV group ✓			
	*Customer's own fabric											II group ✓			
HPL	73 - white high gloss							✓	✓						
	74 - orange high gloss							✓							
	80 - green high gloss							✓							
	81 - burgundy high gloss							✓							
	101 - black high gloss							✓	✓						
	102 - yellow high gloss							✓							
	108 - blue high gloss							✓							
	127 - dark pink high gloss							✓							
	148 - grey high gloss							✓							
	155 - anthracite high gloss							✓							

* Employing the customer's fabric requires running upholstery tests in order to check the possibility of realisation.

*** There is a possibility of ordering the product in full colour spectrum of Silvertex range, as per Spradling's pattern book, within 15 working days.

** There is a possibility of ordering the product in full colour spectrum of Atlantic range, as per Gabriel's pattern book, within 8 weeks

Desks

- 1 Top** - choose from:
 - MFC 12 mm, ABS edge
 - tempered glass, satin, matt 10 mm, colour: white (ultra clear), black, painted underneath
- 2 Chrome decorative element**
- 3 Frame** - aluminum, powder coated steel with chrome details 50x50 mm
- 4 Profile** - powder coated steel - clour: 08 black
- 5 Vertical cable organizer** - plexiglas, standard (1piece per desk IM10);
- 6 Leveling** - 5 mm range
- 7 OPTION WITH EXTRA CHARGE** - only for desks with MFC top:
 - Mediaport S91E - 2x 230V, 2x RJ45

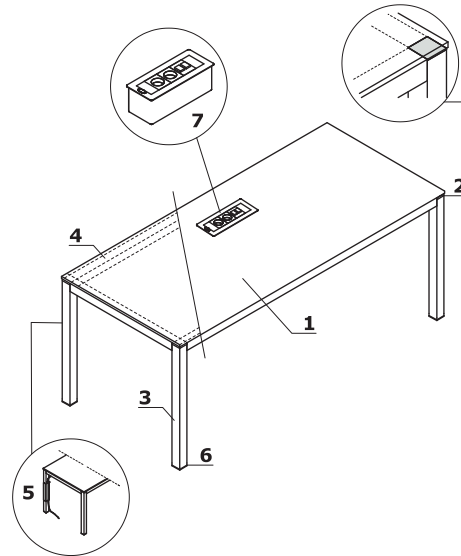

ATTENTION - mediaport can be placed only at marked location

Mfc modesty screens

- 1 Modesty panel** - MFC 18 mm, ABS edge

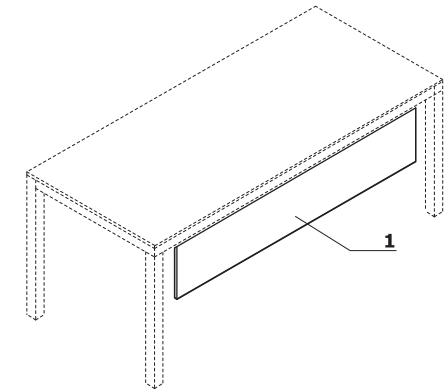
**Extension**

- 1 Top** - choose from:
 - MFC 12 mm, ABS edge
 - tempered glass, satin, matt 10 mm, colour: white (ultra clear), black, painted underneath
- 2 Frame** - aluminum, powder coated steel with chrome details 50x50 mm
- 3 Chrome decorative element**

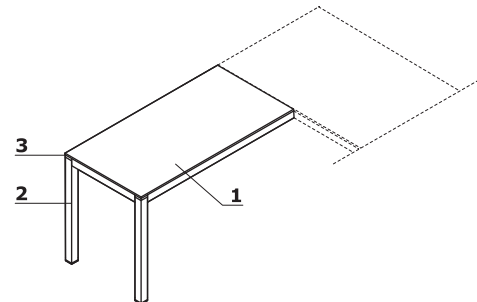

ATTENTION - universal (left, right);

Cabinet

- 1 Top panel** - choose from:
 - MFC 12 mm, ABS edge
 - tempered glass, satin 10 mm, painted underneath
- 2 Side panels** - MFC 18 mm, ABS edge
- 3 Shelf** - MFC 18 mm, protection against accidental falling-out, ABS edge
- 4 Front** - push-to-open - choose from:
 - MFC 18 mm, ABS edge
 - tempered glass, satin 4 mm, painted underneath
- 5 Leveling feet** - range 5 mm

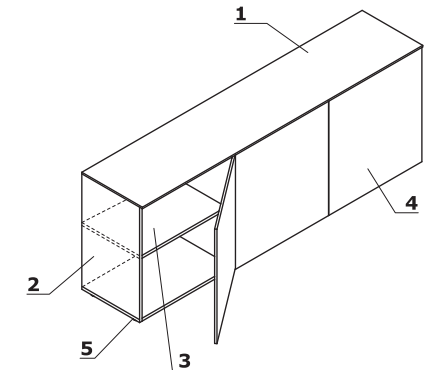

Modular table

- 1 **Worktop** - MFC 12 mm, ABS edge
- 2 **Frame** - aluminum, powder coated steel with chrome details 50x50 mm
- 3 **Chrome decorative element**
- 4 **Profile** - powder coated steel - clour: 08 black
- 5 **Leveling** - 5 mm range
- 6 **Mediaport S91E** - OPTION WITH EXTRA CHARGE - 2x 230V, 2x RJ45
- 7 **Mediaport S92E** - OPTION WITH EXTRA CHARGE - 4x 230V, 4x RJ45

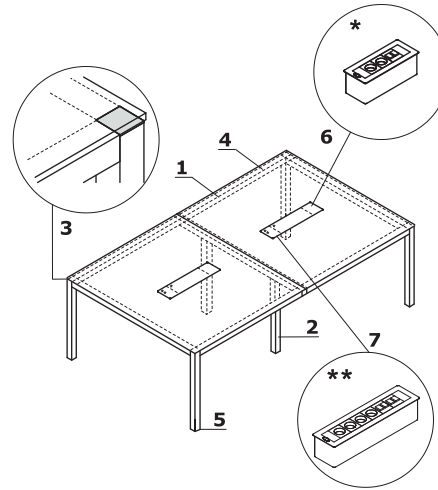

ATTENTION - mediaport can be placed only at marked location

Configuration examples

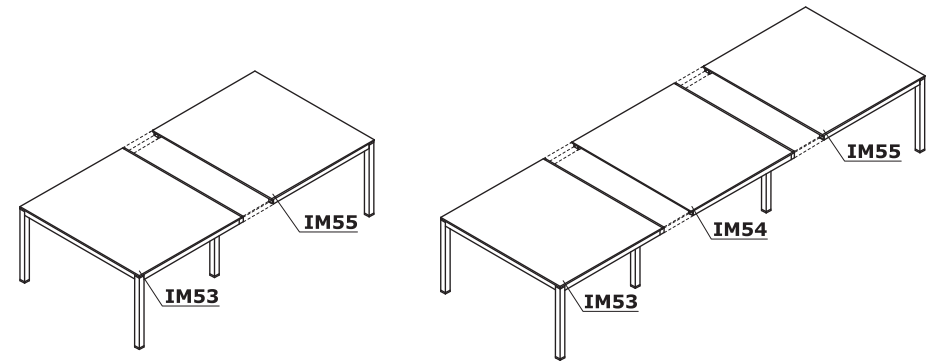

IM53 - Beginning element | IM54 - middle element | IM55 - ending element

Mobile pedestal without handles

- 1 **Top** - MFC 18 mm, coated with HPL high gloss
- 2 **Body** - MFC 18 mm, ABS edge
- 3 **Metal drawer** - roll runners, max load 25 kg, 80% extraction, anti-tilt mechanism; OPTION WITH EXTRA CHARGE - ball runners, soft-closing system
- 4 **Castors** - Ø50 mm, two with brakes
- 5 **Front** - MFC 18 mm, coated with HPL high gloss, ABS edge
- 6 **Central lock** - foldable key
- 7 **Pencil tray** - plastic, colour: black
- 8 **Optional cushion SKP13** - for pedstal, max load 120 kg, ordered separately
- 9 **Suspension files drawer** - ball runners, max load 30 kg, 100% extraction, A4 folders can be situated parallelly and perpendicularly to the front

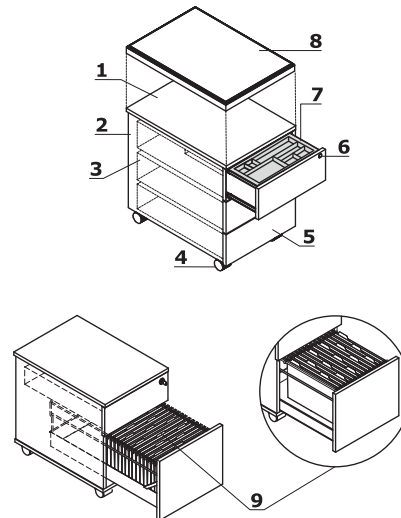

ATTENTION - sitting on the pedestal possible only after mounting the cushion (SKP13); the pedestal with cushion is intended for sitting only - moving the pedestal while sitting may result in damaging the castors

Storages with HPL front

- 1 **Top** - MFC 28 mm, ABS edge
- 2 **Side panels** - MFC 18 mm, ABS edge
- 3 **Leveling feet 27 mm** - range 5 mm
- 4 **Front** - Push-to-Open, coated with HPL high gloss
- 5 **Shelf** - MFC 18 mm, protection against accidental falling-out, ABS edge
- 6 **Base** - MFC 18 mm, ABS edge
- 7 **OPTION WITH EXTRA CHARGE** - top A80GT - MFC 28 mm + LACOBEL glass 4 mm, ordered separately
- 8 **Back MFC** - 18 mm, ABS edges
- 9 **Patent lock**

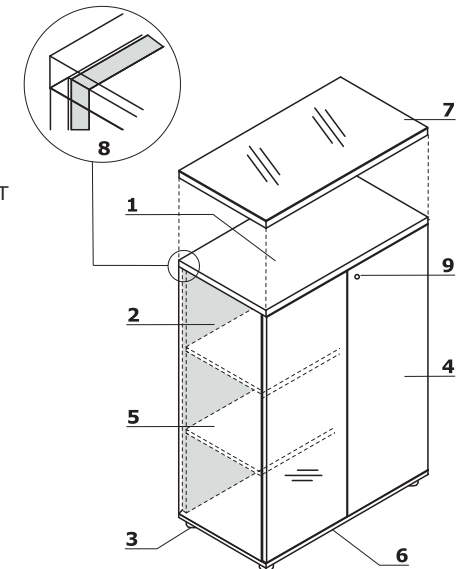

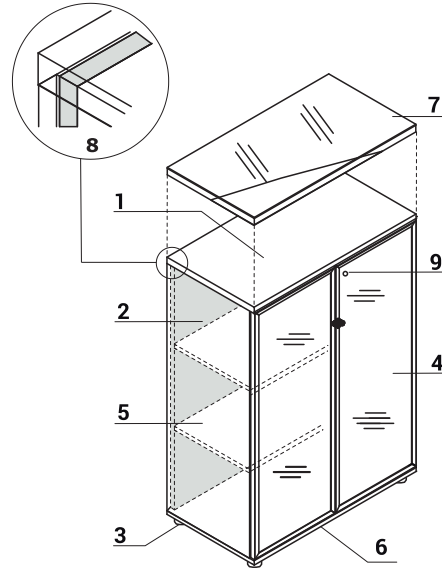

Glass door storages

- 1 **Top** - MFC 28 mm, ABS edge
- 2 **Side panels** - MFC 18 mm, ABS edge
- 3 **Leveling feet 27 mm** - range 5 mm
- 4 **Front** - transparent tempered glass in aluminum frame
- 5 **Shelf** - MFC 18 mm, protection against accidental falling-out, ABS edge
- 6 **Base** - MFC 18 mm, ABS edge
- 7 **OPTION WITH EXTRA CHARGE** - top A800GT - MFC 28 mm + LACOBEL glass 4 mm, ordered separately
- 8 **Back MFC** - 18 mm, ABS edges
- 9 **Aluminum handle**

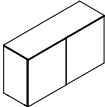
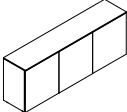
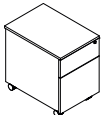
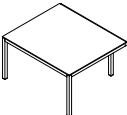
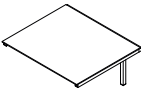
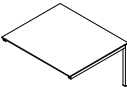



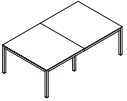
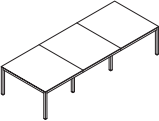
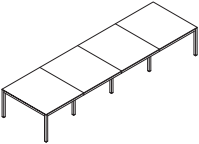
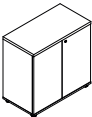
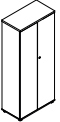

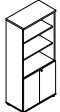

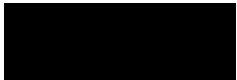

Cabinet							
	Symbol	Price RON with TVA	Dimensions			kg m3 pcs	Comments
			Width	Depth	Height		
	IM21	2340,-	1334	432	740	59 kg 0.122 m3 2 pcs	
	IM21S	6162,-	1334	432	740	59 kg 0.122 m3 2 pcs	credenza with glass
	IM20	2834,-	2000	432	740	105 kg 0.15 m3 2 pcs	
	IM20S	8034,-	2000	432	740	105 kg 0.15 m3 2 pcs	credenza with glass
Mobile pedestals without handles with HPL top and front							
	SLD12HT	2340,-	416	600	587	23 kg 0.158 m3 1 pcs	mobile with suspension files drawer, drawers depth - 500 mm, front and top - HPL, all in one colour
	SLD13HT	2236,-	416	600	587	23 kg 0.158 m3 1 pcs	drawers depth - 500 mm, front and top - HPL, all in one colour
Modular table							
	IM53	4628,-	1200	1400	760	26.5 kg 0.091 m3 2 pcs	starting element
	IM54	3692,-	1200	1400	760	22.5 kg 0.091 m3 2 pcs	middle element
	IM55	4030,-	1200	1400	760	21 kg 0.076 m3 2 pcs	ending element

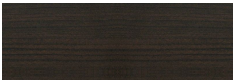

Extra charge RON with TVA							
Self closing system	Ball runners	Mediaport S91E	Mediaport S92E				
151,-	57,-						
151,-	172,-						
		1820,-	2730,-				
		1820,-	2730,-				
		1820,-	2730,-				









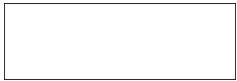

Meeting tables - pre-defined configurations							
	Symbol	Price RON with TVA	Dimensions			kg m3 pcs	Comments
			Width	Depth	Height		
	IM58	8658,-	2400	1400	760	47.5 kg 0.167 m3 4 pcs	Composition elements: IM53 + IM55
	IM59	12324,-	3600	1400	760	70 kg 0.258 m3 6 pcs	Composition elements: IM53 + IM54 + IM55
	IM60	16016,-	4800	1400	760	92.5 kg 0.349 m3 8 pcs	Composition elements: IM53 + IM54 x2 + IM55
Storages with HPL front							
	A2104HZ	1898,-	801	432	777	35 kg 0.093 m3 3 pcs	front HPL, 20H
	A3104HZ	2236,-	801	432	1129	44 kg 0.12 m3 3 pcs	front HPL, 30H
Storages with HPL front							
	A5104HZ	3328,-	801	432	1833	95.7 kg 0.231 m3 5 pcs	front HPL, 50H
	A3404HZ	1950,-	801	432	1129	40 kg 0.111 m3 3 pcs	front HPL, 30H
	A5404HZ	2392,-	801	432	1833	80 kg 0.205 m3 5 pcs	front HPL, 50H

Extra charge RON with TVA									
Metal kick plate	Glass Top A800GT								
218,-	624,-								
218,-	624,-								
218,-									
218,-	624,-								
218,-									









MFC							
 08 - black	 31 - canadian oak	 34 - chestnut	 67 - white pastel				
 167 - grey oak	 168 - natural oak						

Metal					
 M115 black	 M015 - white semi-matt RAL 9010				



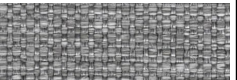





Glass	
 116 - glass black - RAL 9005	 117 - glass white - RAL 9003

HPL							
 73 - white high gloss	 74 - orange high gloss	 80 - green high gloss	 81 - burgundy high gloss	 101 - black high gloss	 102 - yellow high gloss	 108 - blue high gloss	 127 - dark pink high gloss
 148 - grey high gloss	 155 - anthracite high gloss						

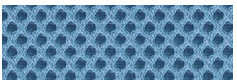
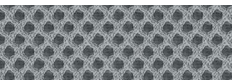

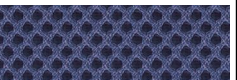

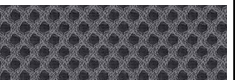
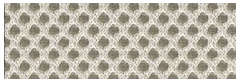



Fabric Nemo - first price group

 NE-1 - beige	 NE-2 - yellow	 NE-3 - orange	 NE-5 - red	 NE-9 - green	 NE-10 - grey	 NE-14 - graphite	 NE-15 - navy blue
 NE-16 - black	 NE-17 - blue						



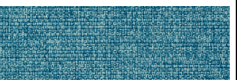







Fabric Runner - second price group

 R-63034 - orange	 R-64089 - red	 R-66063 - blue	 R-60011 - grey	 R-68056 - green	 R-66064 - navy blue	 R-60999 - black	 R-60025 - graphite
 R-61128 - beige	 R-61130 - brown						

Fabric Medley - second price group

 M-68005 - dark olive	 M-68002 - light olive	 M-68115 - green	 M-61002 - beige	 M-67053 - dark blue	 M-67006 - light blue	 M-66008 - grey	 M-64019 - red
 M-63064 - pink	 M-60999 - black						

Fabric Atlantic - second price group (Remaining Atlantic colours, as per Gabriel's pattern book, available within 8 weeks)

 A-67043 - dark turquoise	 A-67030 - aquamarine	 A-60141 - light grey	 A-60011 - grey	 A-66064 - navy blue	 A-65037 - violet	 A-62048 - olive	 A-64089 - red
 A-61078 - beige	 A-60025 - graphite						

Fabric River - second price group

 RV21 - beige	 RV24 - light brown	 RV28 - dark brown	 RV34 - green grey	 RV38 - dark green	 RV41 - mustard	 RV51 - orange	 RV79 - navy blue
 RV87 - aquamarine	 RV91 - grey	 RV100 - black					







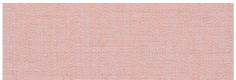

Fabric Synergy - third price group

 LDS08 - grey melange	 LDS20 - light grey	 LDS27 - black	 LDS29 - dark grey	 LDS50 - dark green	 LDS53 - green	 LDS57 - turquoise	 LDS60 - bottle green
 LDS61 - plum	 LDS69 - navy blue	 LDS84 - orange	 LDS86 - red	 LDS88 - aubergine	 LDS85 - coral	 LDS19 - beige	 LDS44 - yellow
 LDS79 - brown							

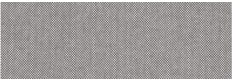
Fabric Xtreme - third price group

 XR160 - aquamarine	 XR430 - dark turquoise	 XR026 - navy blue	 XR084 - violet	 XR009 - black	 XR420 - olive	 XR081 - dark grey	 XR094 - grey
 XR108 - beige	 XR079 - red	 YS071 - light brown					

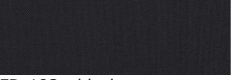
Fabric Atlas - fourth price group							
 AS-531 - orange	 AS-501 - pink	 AS-651 - red	 AS-681 - burgundy	 AS-391 - brown	 AS-781 - navy blue	 AS-161 - dark grey	 AS-111 - light grey
 AS-971 - light green	 AS-981 - dark green						

Fabric Field2 - fourth price group							
 FD-463 - yellow	 FD-963 - green	 FD-123 - beige	 FD-132 - grey	 FD-142 - graphite	 FD-662 - red	 FD-782 - navy blue	 FD-693 - burgundy
 FD-192 - black	 FD-673 - blue-red						