

**smart interior design**

FOR YOUR OFFICE

WWW.SMARTINTERIOR.RO

**Executive QUANDO**

v1.2022

Quando

54

Colour combination - Quando

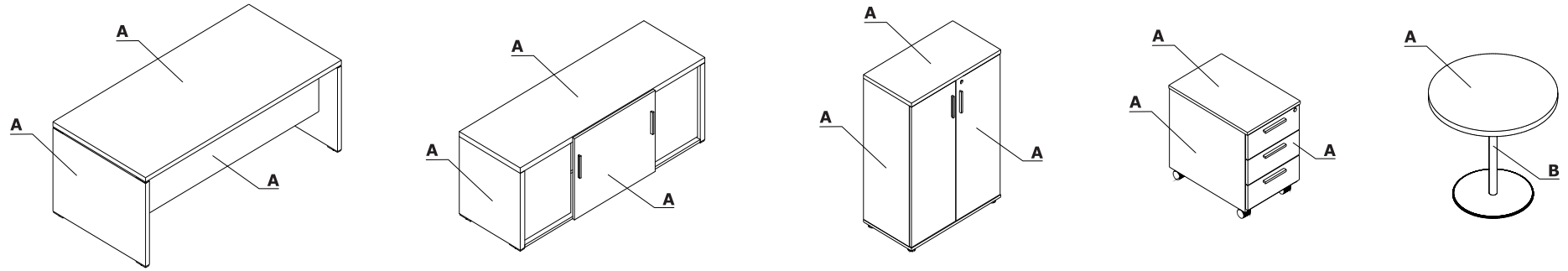

| Material | Colour                              | All elements     | Tables - disc base |  |  |  |  |  |  |  |  |  |  |  |  |  |
|----------|-------------------------------------|------------------|--------------------|--|--|--|--|--|--|--|--|--|--|--|--|--|
|          |                                     | A - MFC elements | B - Column         |  |  |  |  |  |  |  |  |  |  |  |  |  |
| MFC      | 31 - canadian oak                   | ✓                |                    |  |  |  |  |  |  |  |  |  |  |  |  |  |
|          | 34 - chestnut                       | ✓                |                    |  |  |  |  |  |  |  |  |  |  |  |  |  |
|          | 106 - lowland walnut                | ✓                |                    |  |  |  |  |  |  |  |  |  |  |  |  |  |
|          | 167 - grey oak                      | ✓                |                    |  |  |  |  |  |  |  |  |  |  |  |  |  |
|          | 168 - natural oak                   | ✓                |                    |  |  |  |  |  |  |  |  |  |  |  |  |  |
|          | 171 - dark walnut                   | ✓                |                    |  |  |  |  |  |  |  |  |  |  |  |  |  |
| Metal    | M115 - black semi-matt RAL 9005     |                  | ✓                  |  |  |  |  |  |  |  |  |  |  |  |  |  |
|          | M009 - aluminium semi-matt RAL 9006 |                  | ✓                  |  |  |  |  |  |  |  |  |  |  |  |  |  |
|          | M015 - white semi-matt RAL 9010     |                  | ✓                  |  |  |  |  |  |  |  |  |  |  |  |  |  |

## Desks

- 1 **Worktop** - MFC 38 mm, ABS edge
- 2 **Top distance** - aluminium 100x34x9 mm
- 3 **Base** - MFC 38 mm, ABS edge
- 4 **Modesty panel** - MFC 18 mm, ABS edge
- 5 **Leveling feet** - aluminium 100x34x9 mm, range 5 mm

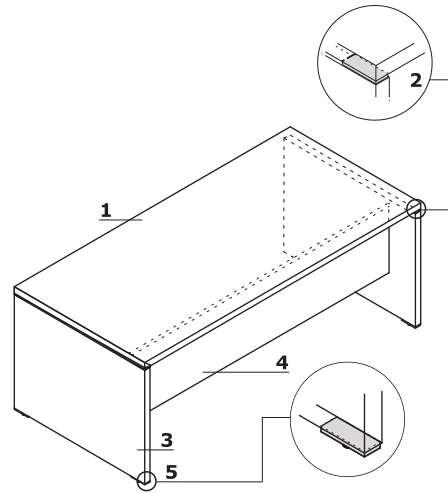

## Configuration examples

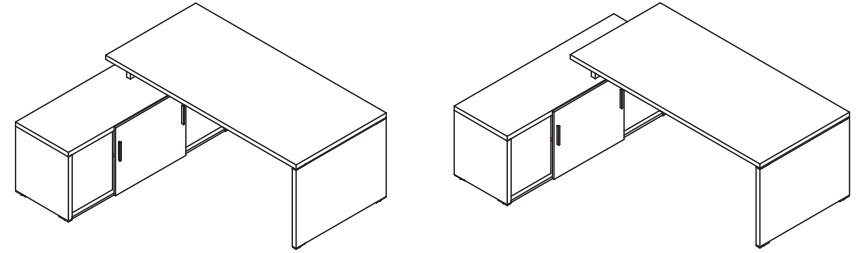

QU16 / QU19

## Configuration examples (mm)

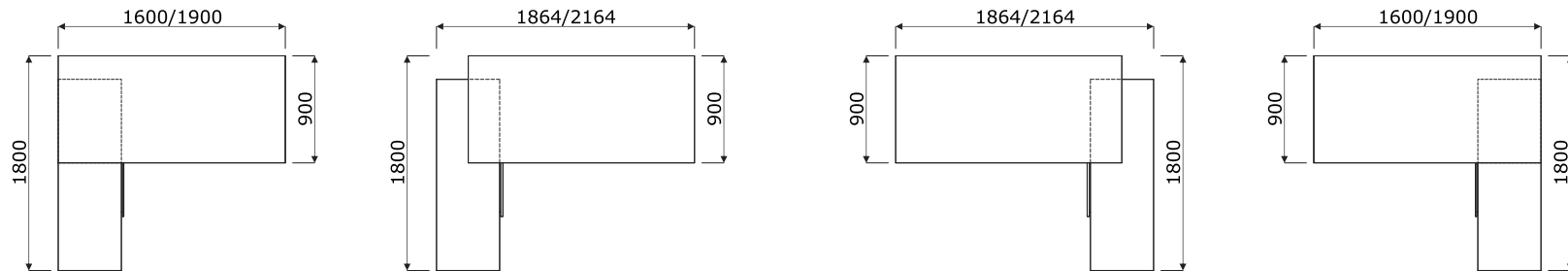

### Cabinet

- 1 **Top** - MFC 38 mm, ABS edge
- 2 **Side panels** - MFC 38 mm, ABS edge
- 3 **Front** - MFC 18 mm, ABS edge
- 4 **Aluminum handle**
- 5 **Sliding front** - MFC 18 mm, ABS edge
- 6 **Shelf** - MFC 18 mm, protection against accidental falling-out, ABS edge
- 7 **Leveling feet** - aluminium 100x34x9 mm, range 5 mm

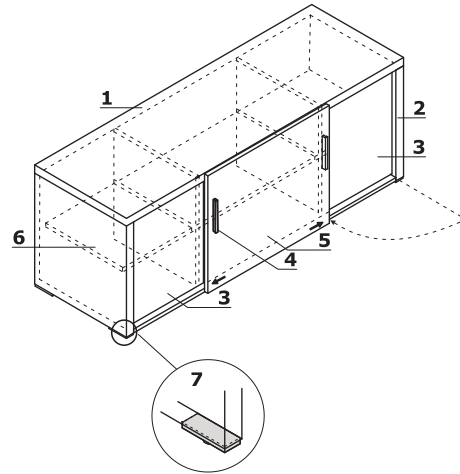

### Mobile pedestal QD13

- 1 **Top** - MFC 18 mm, ABS edge
- 2 **Body** - MFC 18 mm, ABS edge
- 3 **Central lock** - foldable key
- 4 **Aluminum handle**
- 5 **Castors** - Ø50 mm, two with brakes
- 6 **Pencil tray** - plastic, colour: black
- 7 **MFC drawer** - roll runners, max load 25kg, 80% extraction; Anti-tilt mechanism
- 8 **Front** - MFC 18 mm, ABS edge

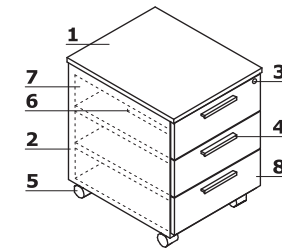

### Storages

- 1 **Top** - MFC 28 mm, ABS edge
- 2 **Side panels** - MFC 18 mm, ABS edge
- 3 **Back MFC** - 18 mm, ABS edges
- 4 **Front** - MFC 18 mm, ABS edge, plain hinge 110°
- 5 **Shelf** - MFC 18 mm, protection against accidental falling-out, ABS edge
- 6 **Base** - MFC 18 mm, ABS edge
- 7 **Aluminum handle**
- 8 **Patent lock**
- 9 **Leveling feet 27 mm** - range 5 mm

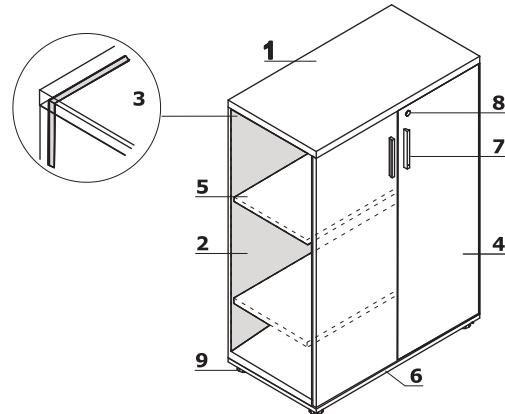

### Storage with sliding front - Q315

- 1 **Top** - MFC 28 mm, ABS edge
- 2 **Side panels** - MFC 18 mm, ABS edge
- 3 **Leveling feet 27 mm** - range 5 mm
- 4 **Base** - MFC 18 mm, ABS edge
- 5 **Shelf** - MFC 18 mm, protection against accidental falling-out, ABS edge
- 6 **Sliding front** - MFC 18 mm, ABS edge

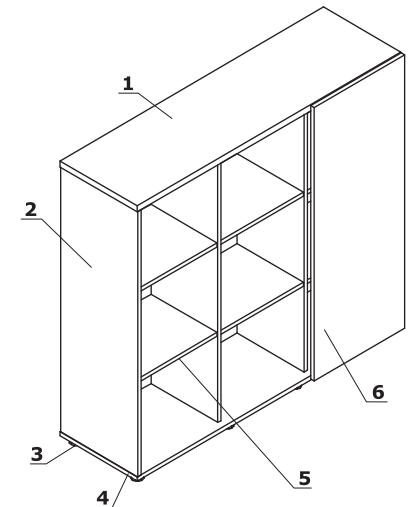

**Additional elements for storages****1 IM300**

- glass door 30H
- transparent tempered glass 4 mm, with aluminum frame

**2 AS300**

- glass door 30H
- frosted tempered glass 4 mm, with aluminum frame

**3 AS31**

- glass door 30H
- transparent tempered glass 4 mm
- universal (left,right)

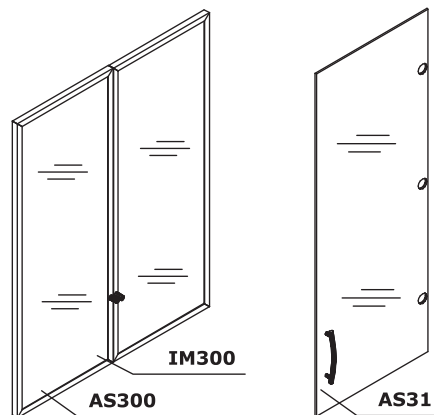
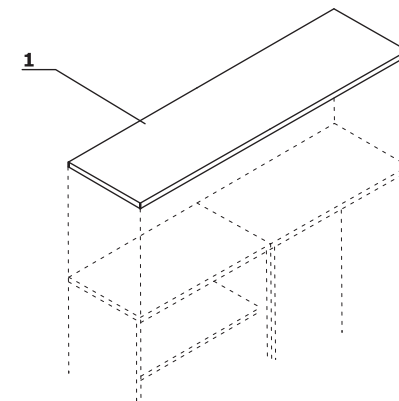
**Optional storage tops****1 Top - MFC 38 mm, ABS edge****MFC base meeting tables**

- 1 Worktop** - MFC 38 mm, ABS edge
- 2 Base** - MFC 38 mm, ABS edge
- 3 Modesty panel** - MFC 18 mm, ABS edge
- 4 Leveling feet** - aluminium 100x34x9 mm, range 5 mm

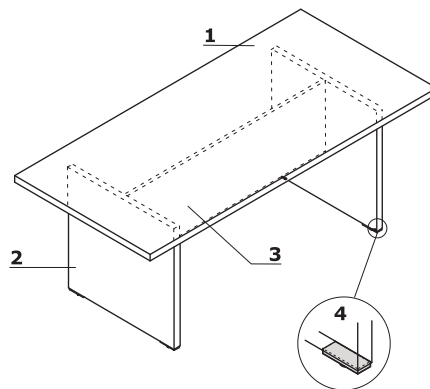
**Disc base meeting tables**

- 1 Worktop** - MFC 38 mm, ABS edge
- 2 Column** - powder coated steel
- 3 Disc** - stainless steel INOX, powder coated

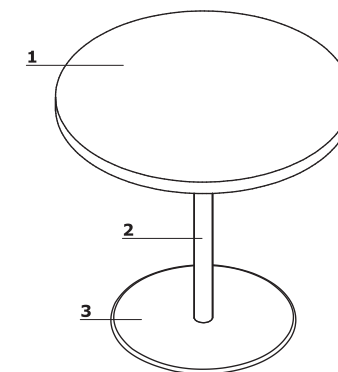

Mediabox location

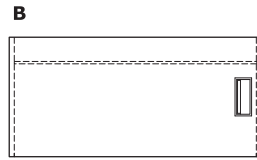
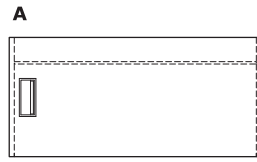

Q16, Q19

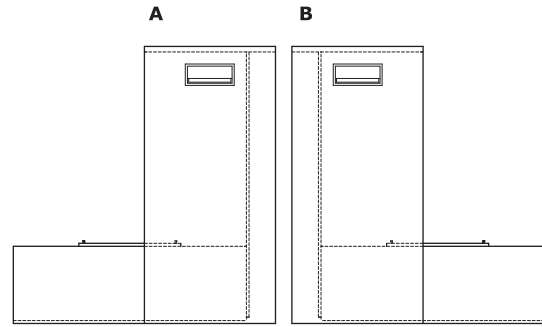

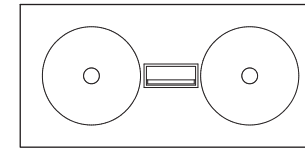

QU16, QU19



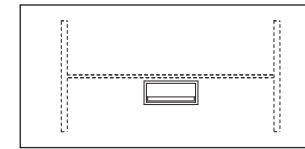

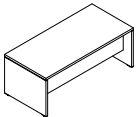
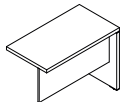
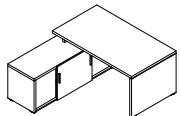
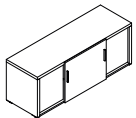

QS20



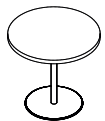
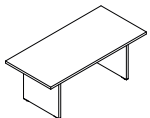
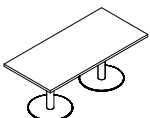

QS19

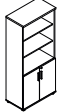
| Desks   |        |                    |              |             |        |                                |                                |
|---|--------|--------------------|--------------|-------------|--------|--------------------------------|--------------------------------|
|   | Symbol | Price RON with TVA | Dimensions   |             |        | kg m3 pcs                      | Comments                       |
|   |        |                    | Width        | Depth       | Height |                                |                                |
|    | Q19    | 2527,-             | 1900         | 900         | 740    | 93.65 kg<br>0.203 m3<br>5 pcs  |                                |
|   | Q16    | 2340,-             | 1600         | 900         | 740    | 86.2 kg<br>0.175 m3<br>5 pcs   |                                |
| Desk extension  |        |                    |              |             |        |                                |                                |
|    | Q10    | 1435,-             | 1000         | 550         | 740    | 31.7 kg<br>0.066 m3<br>1 pcs   | universal left or right        |
| Desks with managerial storage   |        |                    |              |             |        |                                |                                |
|    | QU16   | 4618,-             | 1600<br>1864 | 900<br>1800 | 740    | 163.95 kg<br>0.331 m3<br>6 pcs | universal system left or right |
|   | QU19   | 4805,-             | 1900<br>2164 | 900<br>1800 | 740    | 171.4 kg<br>0.358 m3<br>6 pcs  |                                |
| Cabinet   |        |                    |              |             |        |                                |                                |
|   | QR16   | 2714,-             | 1600         | 550         | 610    | 94.75 kg<br>0.186 m3<br>2 pcs  |                                |
| Pedestal  |        |                    |              |             |        |                                |                                |
|  | QD13   | 1061,-             | 402          | 600         | 590    | 30 kg<br>0.142 m3<br>1 pcs     |                                |
| Meeting tables  |        |                    |              |             |        |                                |                                |
|  | QSL08  | 1654,-             | 800          | 800         | 550    | 31.25 kg<br>0.077 m3<br>2 pcs  |                                |
|   | QS08   | 1706,-             | 800          | 800         | 740    | 36.8 kg<br>0.089 m3<br>2 pcs   |                                |

| Extra charge RON with TVA |              |            |  |  |  |  |  |  |  |
|---------------------------|--------------|------------|--|--|--|--|--|--|--|
| Mediabox M04H             | Mediabox M04 | Top access |  |  |  |  |  |  |  |
| 562,-                     | 504,-        | 192,-      |  |  |  |  |  |  |  |
| 562,-                     | 504,-        | 192,-      |  |  |  |  |  |  |  |
|                           |              |            |  |  |  |  |  |  |  |
|                           |              |            |  |  |  |  |  |  |  |
| 562,-                     | 504,-        | 192,-      |  |  |  |  |  |  |  |
| 562,-                     | 504,-        | 192,-      |  |  |  |  |  |  |  |
|                           |              |            |  |  |  |  |  |  |  |
|                           |              |            |  |  |  |  |  |  |  |
|                           |              |            |  |  |  |  |  |  |  |
|                           |              |            |  |  |  |  |  |  |  |

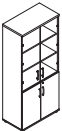
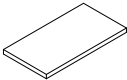

| Meeting tables  |             |                    |            |       |        |                               |                              |
|---|-------------|--------------------|------------|-------|--------|-------------------------------|------------------------------|
|   | Symbol      | Price RON with TVA | Dimensions |       |        | kg m3 pcs                     | Comments                     |
|   |             |                    | Width      | Depth | Height |                               |                              |
|    | <b>QS09</b> | <b>3006,-</b>      | 800        | 800   | 740    | 34.25 kg<br>0.113 m3<br>3 pcs | column Ø50 mm, disc ø 500 mm |
|   | <b>QS12</b> | <b>3297,-</b>      | 1200       | 1200  | 740    | 60.25 kg<br>0.165 m3<br>3 pcs | column ø100 mm, disc ø620 mm |
|    | <b>QS19</b> | <b>2954,-</b>      | 1900       | 900   | 740    | 79.55 kg<br>0.154 m3<br>3 pcs |                              |
|    | <b>QS20</b> | <b>6292,-</b>      | 1900       | 900   | 740    | 103.55 kg<br>0.24 m3<br>5 pcs | column ø100 mm, disc ø620 mm |
| Storages  |             |                    |            |       |        |                               |                              |
|    | <b>Q31</b>  | <b>1591,-</b>      | 801        | 432   | 1129   | 56.3 kg<br>0.116 m3<br>3 pcs  | 30H                          |
|   | <b>Q51</b>  | <b>2153,-</b>      | 801        | 432   | 1833   | 86.1 kg<br>0.213 m3<br>3 pcs  | 50H                          |
|   | <b>Q35</b>  | <b>1196,-</b>      | 801        | 432   | 1129   | 44.75 kg<br>0.088 m3<br>2 pcs | 30H                          |
|  | <b>Q54</b>  | <b>1810,-</b>      | 801        | 432   | 1833   | 74.5 kg<br>0.186 m3<br>3 pcs  | 50H                          |
|  | <b>Q315</b> | <b>3775,-</b>      | 1400       | 432   | 1280   | 87.6 kg<br>0.187 m3<br>3 pcs  | sliding door, 30H            |

| Extra charge RON with TVA |              |            |                  |  |  |  |  |
|---------------------------|--------------|------------|------------------|--|--|--|--|
| Mediabox M04H             | Mediabox M04 | Top access | Mediabox cut-out |  |  |  |  |
|                           |              |            |                  |  |  |  |  |
| 562,-                     | 504,-        | 192,-      | 21,-             |  |  |  |  |
| 562,-                     | 504,-        | 192,-      | 21,-             |  |  |  |  |
|                           |              |            |                  |  |  |  |  |
|                           |              |            |                  |  |  |  |  |
|                           |              |            |                  |  |  |  |  |
|                           |              |            |                  |  |  |  |  |



| Glass door storages   |             |                    |            |       |        |                               |                              |
|---|-------------|--------------------|------------|-------|--------|-------------------------------|------------------------------|
|   | Symbol      | Price RON with TVA | Dimensions |       |        | kg m3 pcs                     | Comments                     |
|   |             |                    | Width      | Depth | Height |                               |                              |
|    | <b>Q35W</b> | <b>2122,-</b>      | 801        | 432   | 1129   | 57.45 kg<br>0.157 m3<br>4 pcs |                              |
|    | <b>Q54W</b> | <b>2735,-</b>      | 801        | 432   | 1833   | 88.5 kg<br>0.253 m3<br>5 pcs  |                              |
| Optional storage tops   |             |                    |            |       |        |                               |                              |
|    | <b>QT08</b> | <b>265,-</b>       | 806        | 434   | 38     | 9.3 kg<br>0.023 m3<br>1 pcs   |                              |
|   | <b>QT16</b> | <b>374,-</b>       | 1608       | 434   | 38     | 19 kg<br>0.044 m3<br>1 pcs    |                              |
|   | <b>QT24</b> | <b>504,-</b>       | 2410       | 434   | 38     | 27.95 kg<br>0.066 m3<br>1 pcs |                              |
| Additional elements   |             |                    |            |       |        |                               |                              |
|   | <b>HQ2</b>  | <b>161,-</b>       | 12         | 17    | 158    | 0.1 kg<br>0 m3<br>1 pcs       | handles QUANDO (2 pcs);      |
|  | <b>M04</b>  | <b>515,-</b>       | 275        | 120   | 140    | 1.6 kg<br>0.008 m3<br>1 pcs   | 4x230V, 2xRJ45, 1xUSB        |
|   | <b>M04H</b> | <b>562,-</b>       | 275        | 120   | 140    | 2 kg<br>0.013 m3<br>2 pcs     | 4x230V, 2xRJ45, 1xUSB, 1xHDM |
|   | <b>M05</b>  | <b>192,-</b>       | 275        | 120   | 25     | 0.3 kg<br>0.002 m3<br>1 pcs   | top access                   |





| Extra charge RON with TVA |                  |  |  |  |  |  |  |  |  |
|---------------------------|------------------|--|--|--|--|--|--|--|--|
| Glass door AS300          | Glass door IM300 |  |  |  |  |  |  |  |  |
| 400,-                     | 296,-            |  |  |  |  |  |  |  |  |
| 400,-                     | 296,-            |  |  |  |  |  |  |  |  |
|                           |                  |  |  |  |  |  |  |  |  |
|                           |                  |  |  |  |  |  |  |  |  |
|                           |                  |  |  |  |  |  |  |  |  |
|                           |                  |  |  |  |  |  |  |  |  |
|                           |                  |  |  |  |  |  |  |  |  |
|                           |                  |  |  |  |  |  |  |  |  |
|                           |                  |  |  |  |  |  |  |  |  |
|                           |                  |  |  |  |  |  |  |  |  |
|                           |                  |  |  |  |  |  |  |  |  |
|                           |                  |  |  |  |  |  |  |  |  |
|                           |                  |  |  |  |  |  |  |  |  |
|                           |                  |  |  |  |  |  |  |  |  |
|                           |                  |  |  |  |  |  |  |  |  |
|                           |                  |  |  |  |  |  |  |  |  |
|                           |                  |  |  |  |  |  |  |  |  |
|                           |                  |  |  |  |  |  |  |  |  |

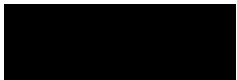







| MFC  |  |  |   |   |   |   |  |
|--|--|--|---|---|---|---|--|
| <br>08 - black      | <br>31 - canadian oak | <br>34 - chestnut     | <br>67 - white pastel | <br>106 - lowland walnut | <br>154 - anthracite | <br>167 - grey oak | <br>168 - natural oak |
| <br>169 - honey oak | <br>170 - acacia      | <br>171 - dark walnut | <br>172 - amber oak   | <br>173 - robinia        |   |   |  |



| Veneer   |  |
|--|--|
| <br>156 - elm | <br>157 - american walnut |

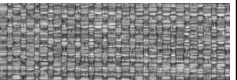

| Metal   |   |  |  |   |
|---|---|--|--|---|
| <br>M009 - aluminium semi-matt<br>RAL 9006 | <br>M015 - white semi-matt RAL<br>9010 | <br>M154 - anthracite semi-matt<br>RAL 7043 | <br>154 - anthracite | <br>Stainless steel INOX |

| Glass  |  |
|--|--|
| <br>116 - glass black - RAL 9005 | <br>117 - glass white - RAL 9003 |

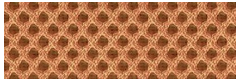
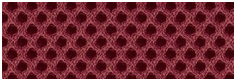
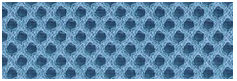
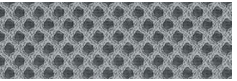
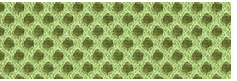
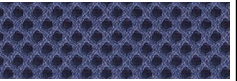
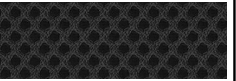
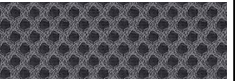
| HPL  |   |  |   |
|--|---|--|---|
| <br>73 - white high gloss | <br>101 - black high gloss | <br>155 - anthracite high gloss | <br>158 - Graphite RAL 9004 |



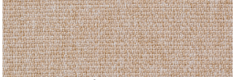











| Fabric Nemo - first price group  |  |  |  |   |   |   |  |
|--|--|--|--|---|---|---|--|
| <br>NE-1 - beige  | <br>NE-2 - yellow | <br>NE-3 - orange | <br>NE-5 - red | <br>NE-9 - green | <br>NE-10 - grey | <br>NE-14 - graphite | <br>NE-15 - navy blue |
| <br>NE-16 - black | <br>NE-17 - blue  |  |  |   |   |   |  |

| Fabric Runner - second price group  |  |   |  |  |  |  |   |
|---|--|---|--|--|--|--|---|
| <br>R-63034 - orange | <br>R-64089 - red   | <br>R-66063 - blue | <br>R-60011 - grey | <br>R-68056 - green | <br>R-66064 - navy blue | <br>R-60999 - black | <br>R-60025 - graphite |
| <br>R-61128 - beige  | <br>R-61130 - brown |   |  |  |  |  |   |

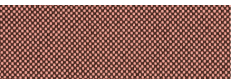











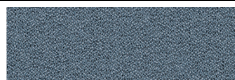

| Fabric Medley - second price group   |   |  |   |   |  |   |  |
|--|---|--|---|---|--|---|--|
| <br>M-66008 - grey  | <br>M-60003 - light grey   | <br>M-61189 - beige | <br>M-68005 - dark olive  | <br>M-62002 - yellow | <br>M-62054 - mustard | <br>M-63017 - rust-brown | <br>M-64019 - red |
| <br>M-63064 - pink | <br>M-65011 - grey-violet | <br>M-66010 - blue | <br>M-67006 - light blue | <br>M-60999 - black |  |   |  |

| Fabric Atlantic - second price group (Remaining Atlantic colours, as per Gabriel's pattern book, available within 8 weeks) |   |   |  |  |   |  |  |
|--|---|---|--|--|---|--|--|
| <br>A-67043 - dark turquoise            | <br>A-67030 - aquamarine | <br>A-60141 - light grey | <br>A-60011 - grey | <br>A-66064 - navy blue | <br>A-65037 - violet | <br>A-62048 - olive | <br>A-64089 - red |
| <br>A-61078 - beige                     | <br>A-60025 - graphite   |   |  |  |   |  |  |

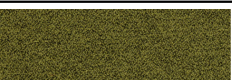
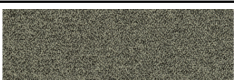
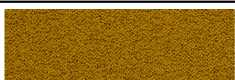
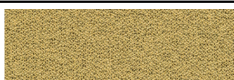

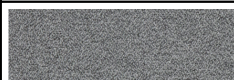

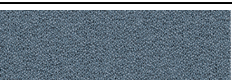
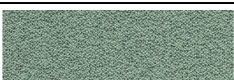
**Fabric Go check - second price group**

|  |  |  |   |  |   |  |   |
|--|--|--|---|--|---|--|---|
| <br>G-66136 - blue    | <br>G-66137 - dark blue | <br>G-66134 - dark violet | <br>G-66138 - navy blue | <br>G-66140 - inky  | <br>G-68149 - dark green | <br>G-68152 - green | <br>G-60079 - grey |
| <br>G-64183 - marsala | <br>G-63079 - orange    | <br>G-64171 - red         | <br>G-64172 - burgundy  | <br>G-61144 - brown | <br>G-61145 - dark brown |  |   |

**Fabric Mica - second price group**

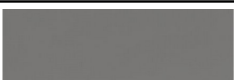
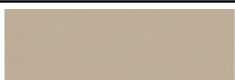
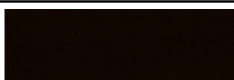
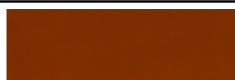
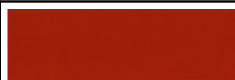
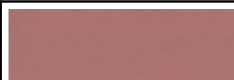
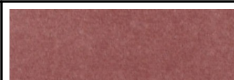
|   |  |   |   |  |   |   |   |
|---|--|---|---|--|---|---|---|
| <br>MC-01 - pink       | <br>MC-02 - red         | <br>MC-03 - dark red | <br>MC-04 - navy blue | <br>MC-05 - blue  | <br>MC-06 - aquamarine | <br>MC-07 - bottle green | <br>MC-08 - green    |
| <br>MC-09 - olive      | <br>MC-10 - light olive | <br>MC-11 - mustard  | <br>MC-12 - yellow    | <br>MC-13 - beige | <br>MC-14 - light grey | <br>MC-15 - grey         | <br>MC-16 - graphite |
| <br>MC-17 - light blue | <br>MC-18 - mint        | <br>MC-19 - burgundy |   |  |   |   |   |



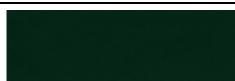





**Fabric Charles - second price group**

|   |  |  |  |   |  |   |  |
|---|--|--|--|---|--|---|--|
| <br>C-01 - black      | <br>C-05 - grey  | <br>C-06 - beige   | <br>C-14 - brown  | <br>C-18 - rust-brown | <br>C-21 - red | <br>C-30 - pink | <br>C-31 - marsala |
| <br>C-32 - dark blue | <br>C-35 - blue | <br>C-41 - yellow | <br>C-44 - olive | <br>C-45 - green     |  |   |  |

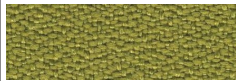
**Fabric Synergy - third price group**

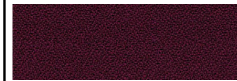
|   |   |   |   |   |  |  |   |
|---|---|---|---|---|--|--|---|
| <br>LDS08 - grey melange | <br>LDS20 - light grey | <br>LDS27 - black  | <br>LDS29 - dark grey | <br>LDS50 - dark green | <br>LDS53 - green | <br>LDS57 - turquoise | <br>LDS60 - bottle green |
| <br>LDS61 - plum         | <br>LDS69 - navy blue  | <br>LDS84 - orange | <br>LDS86 - red       | <br>LDS88 - aubergine  | <br>LDS85 - coral | <br>LDS19 - beige     | <br>LDS44 - yellow       |
| <br>LDS79 - brown        |   |   |   |   |  |  |   |

**Fabric Xtreme - third price group**









|   |   |  |   |  |  |  |   |
|---|---|--|---|--|--|--|---|
| <br>XR108 - beige  | <br>XR094 - grey   | <br>XR081 - dark grey | <br>XR420 - olive | <br>XR009 - black | <br>XR026 - navy blue | <br>YS071 - light brown | <br>YS030 - burgundy |
| <br>YS076 - orange | <br>YS072 - yellow | <br>YS045 - green     | <br>YS100 - blue  |  |  |  |   |

**Fabric Silvertex - third price group - There is a possibility of ordering the product in full colour spectrum of Silvertex range, as per Spradling's pattern book, within 15 working days.**

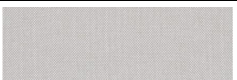
**Fabric Atlas - fourth price group**

|   |  |   |   |   |   |   |  |
|---|--|---|---|---|---|---|--|
| <br>AS-531 - orange      | <br>AS-501 - pink       | <br>AS-651 - red | <br>AS-681 - burgundy | <br>AS-391 - brown | <br>AS-781 - navy blue | <br>AS-161 - dark grey | <br>AS-111 - light grey |
| <br>AS-971 - light green | <br>AS-981 - dark green |   |   |   |   |   |  |

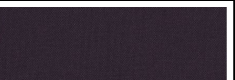
**Fabric Field2 - fourth price group**

|  |  |   |   |  |   |   |  |
|--|--|---|---|--|---|---|--|
| <br>FD-463 - yellow | <br>FD-963 - green    | <br>FD-123 - beige | <br>FD-132 - grey | <br>FD-142 - graphite | <br>FD-662 - red | <br>FD-782 - navy blue | <br>FD-693 - burgundy |
| <br>FD-192 - black  | <br>FD-673 - blue-red |   |   |  |   |   |  |